

SW400DC Swing Gate Opener User Manual

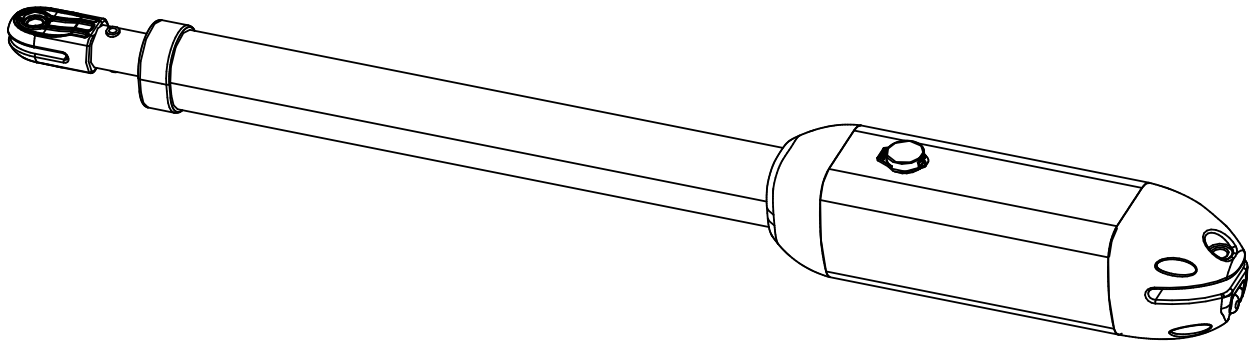

CONTENTS:

1. Safety Instruction.....	1
2. Packing List.....	2
3. Technical Parameters.....	3
4. Installation.....	4
4.1 Installation Drawing.....	4
4.2 Size of Main Machine and Accessories.....	4
4.2.1 Size of Main Machine.....	4
4.2.2 Size of Mounting Plate.....	5
4.3 Installation Steps.....	5
4.3.1 Preparation before Main Machine Installation.....	5
4.3.2 Accessory Installation.....	6
4.3.3 Main Machine Installation.....	7
4.3.4 Size of Control Box.....	9
5. Wiring and Debugging.....	10
5.1 Wiring Instructions.....	10
5.2 Control Board Drawing and Instructions.....	11
5.3 Digital Screen Setting.....	12
5.4 Travel Setting.....	12
5.5 Trimmers Setting.....	13
5.6 Learning Transmitter & Delete Transmitter.....	13
5.7 Control Board Settings.....	14
5.8 Base Menu.....	14
5.9	Advance
Menu.....	
.....	17
6. Others.....	21
6.1 Maintenance.....	21
6.2 Troubleshooting.....	21

Dear users,



Thank you for choosing this product. Please read the manual carefully before assembling and using it. Please do not leave out the manual if you send this product to a third party.

1. Safety Instruction

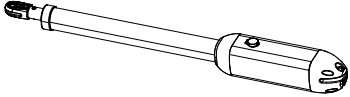
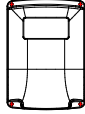
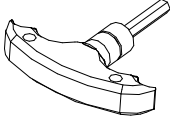
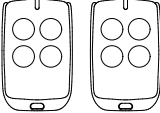
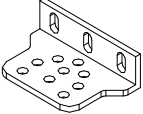
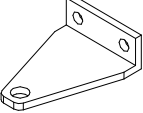
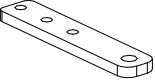
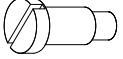
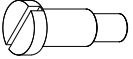
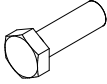

- Please read this manual carefully before installation, in which involves with important information about installation、 using、 maintenance and safety.
- Any undefined operations under this manual is not allowed, incorrect using may damage the product even causing the injuries or property losses.
- To consider the possible danger during the installation or using process of swing gate operator, installation must strictly comply with the construction standard and electrical operating procedure.
- Before installation, please make sure that the power voltage being used matches with the supply voltage of this product. Please check if the leakage protection switch is installed and the grounding system is correct.
- Please check if additional equipments or materials are required to meet the specific requirements.
- The disposal of packaging material must be complying with the local regulation.
- Please do not change any parts except for those defined under this manual. Any undefined changes may cause the malfunction. Any damages to the product arising therefrom shall be beyond the liability of the company.
- Please do not leak water or any liquid into the controller or any other open devices. Please disconnect the power immediately if any mentioned cases happened.
- Please keep this product away from heat and open fire. Or it may damage the components; cause the failure or other hazards.
- Please make sure there is no vehicles、 passengers and objects passing through while the swing gate is moving.
- Anti-clip equipment like infrared protection switch must be installed to avoid injuries to person and property losses. The company shall not be liable for any damage or accident arising therefrom.
- The installation、 using and maintenance of this product must be carried out by professionals.
- Children are not allowed be touch the control devices or remote transmitters.
- A warning sign must be placed somewhere on the swing gate according to the national standard.
- Please keep this instruction properly for future reference.

2. Packing List (Standard)

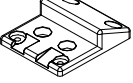
No.	Picture	Name	Quantity
1		Main machine	2
2		Control box	1
3		Manual release bar	1
4		Remote control	2
5		Wall bracket	4
6		Front mounting bracket	2
7		Connecting bracket	2
8		Mounting screw (short)	2
9		Mounting screw (long)	2
10		Screw M8×25	4
11		Nut M8	6
12		Limit stopper	1

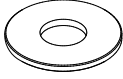
No.	Picture	Name	Quantity
13		Spring washer Ø12	2
14		gasket	2

Packing List (Optional)

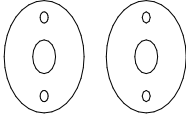
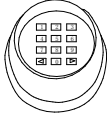
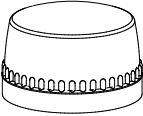
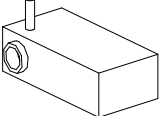
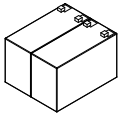
No.	Picture	Name	Quantity
1		Infrared sensor	1
2		Wireless keypad	1
3		Alarm lamp	1
4		Electric lock	1
5		Storage battery	2

3. Technical Parameters

Model	SW400DC
Power supply	220V/50Hz;110V/60Hz
Motor power	62W
Gate moving speed	22~26s / 90°
Max.single-leaf weight	400kg
Max.single-leaf length	3m
Max.piston stroke	45cm
Max.force	2500N
Remote control distance	≥30m
Remote control mode	Single button mode
Storage battery (optional)	DC24V (4.5Ah or 9Ah)

Noise	≤60dB
Working duty	S2, 30min
Recording of up remote controls	32
Remote frequency	433.92 MHz
Working temperature	-20°C - +70°C
Package weight	20kg

4. Installation

SW400DC swing gate opener is applicable to single leaf gate weight less than 400kg, and the length shorter than 3m. The drive mode adopts the worm and worm gear to combine the screw rod transmission. This gate opener must be installed inside the enclosure or yard for protection.

4.1 Installation Drawing

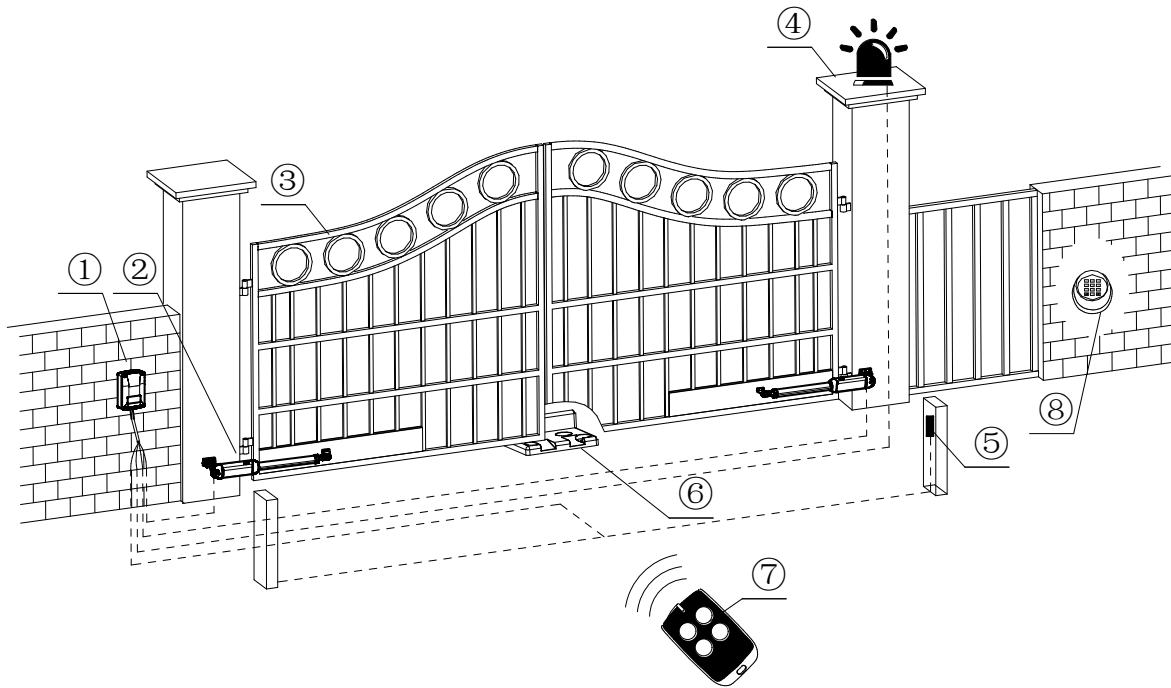

Figure 1

- ① Control box
- ② Gate opener
- ③ Gate
- ④ Alarm lamp (optional)
- ⑤ Infrared sensor (optional)
- ⑥ Limit stopper
- ⑦ Remote control
- ⑧ Wireless keypad (optional)

4.2 Size of Main Machine and Accessories

4.2.1 Size of Main Machine

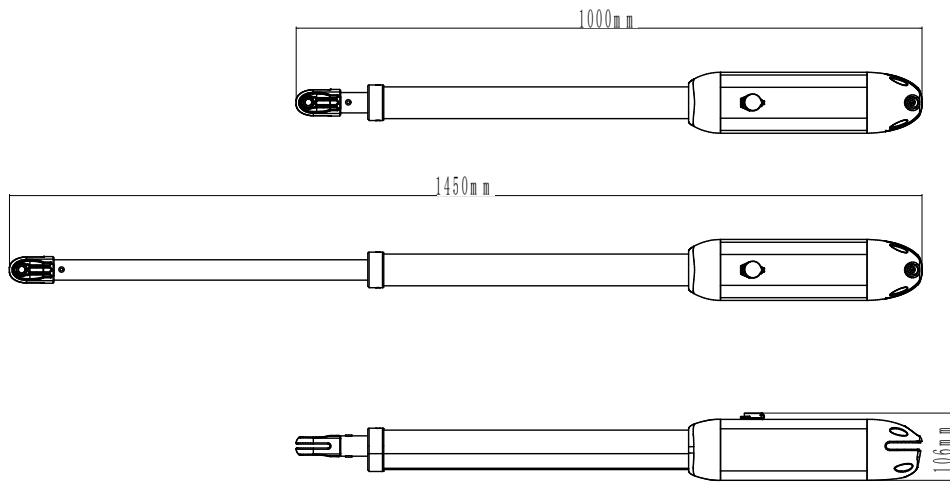

Figure 2

4.2.2 Size of Mounting Plate

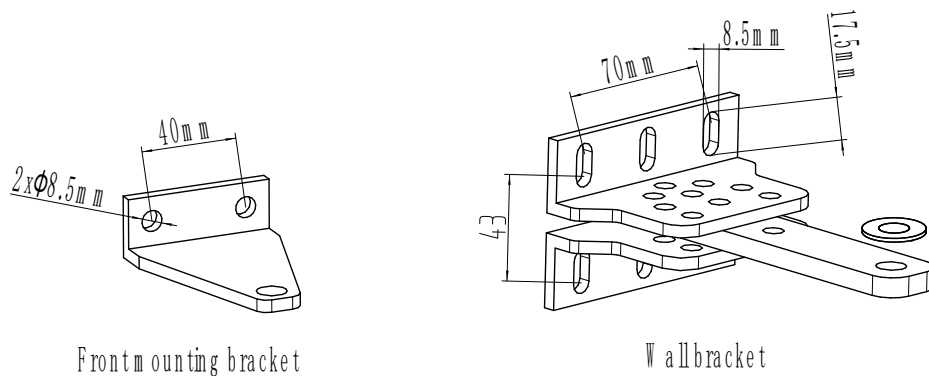

Figure 3

4.3 Installation Steps

4.3.1 Preparation before Main Machine Installation

a) Before installing the door opener, please confirm that the door were installed correctly, please ensure that the door can be manually operated smoothly, and the door limit stopper can effectively prevent the door to continue moving.

b) Please keep a distance of 40-50mm between the door bottom and the ground for installing the electric lock. If electric lock is not required, the distance between the door bottom and the ground should be ≥ 20 mm;

c) The recommended mounting height of the 2 main machines is around 300 ~ 800mm above the ground, and make sure there are reliable fixed points for mounting brackets.

Cable bury

In order to ensure the normal operation of the door opener and protect the cable from damage, please use two PVC pipes to bury the motor and power cables, and the control cables separately.

One PVC pipe for motor and power cables, the other one for control cables.

Mounting brackets fixing

In order to install the SW400DC main machines firmly, it is recommended to use the expansion screws to fix the mounting brackets.

4.3.2 Accessory Installation

a) Before installing the main machines, please install the wall bracket on the wall first, then fix the connecting bracket, finally install the front mounting bracket on the door.

Note: Please detect by gradienter before fixing to ensure that the front mounting bracket and the connecting bracket are in the same level.

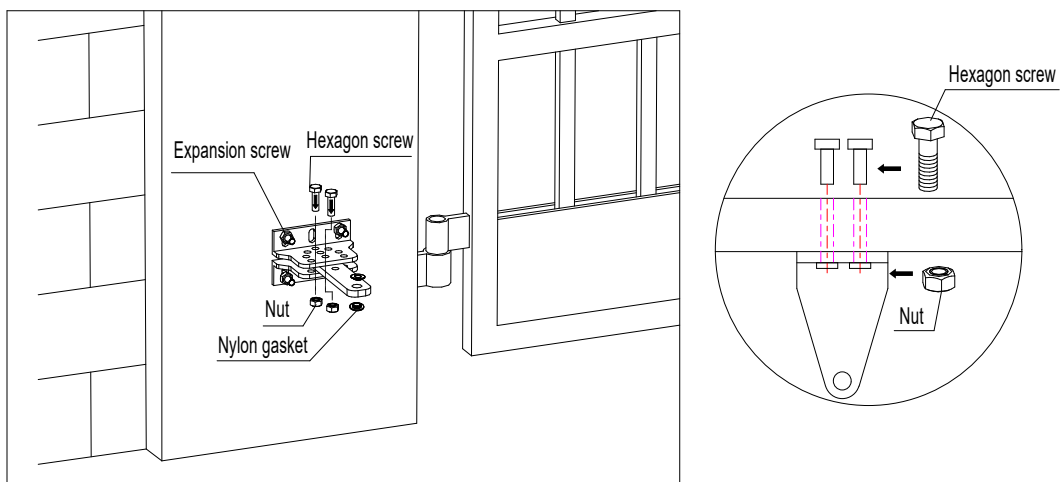

Figure 4

b) The connecting bracket and wall bracket can be connected according to different conditions, please refer to figure 5.

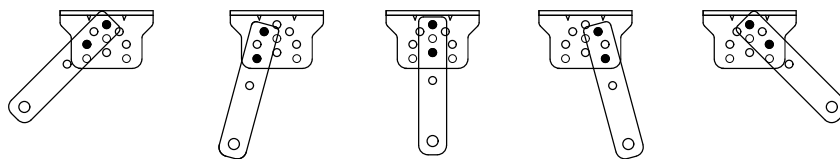

Figure 5

c) Users should prepare power cables for the control box and the main machines by themselves due to the different installation environment. The cores for the control box power supply cable should be more than 3, the cores for the motor cable is 2. If users need to install external accessories like electric lock, infrared sensor, alarm lamp, external button switch etc., please increase the embedded cables accordingly, please make sure the sectional diameter of electric lock cable is over 1.5mm², sectional diameter of other cables is over 0.5mm². The cable length should be determined by users according to their installation situations.

Note: The outlet on the PVC pipe should be downward in order to avoid the rain water flowing into the pipe along the cable.

d) Before the installation, please unlock the two main machines. Unlock method: Remove the cover, insert the manual release bar, rotate the bar until it's released, as shown in Figure 6, then turn the telescopic arm, you'll find it is stretched easily.

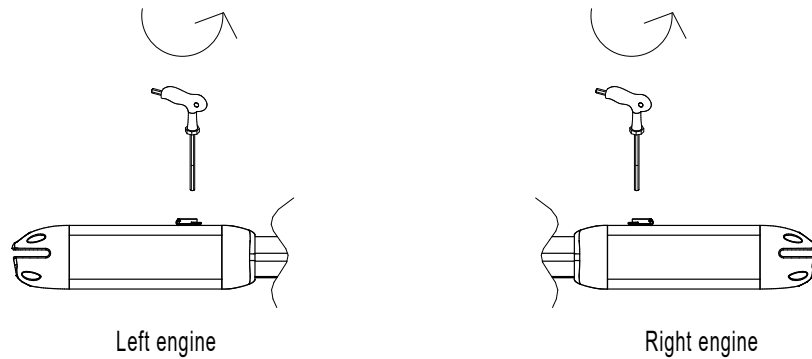

Figure 6

4.3.3 Main Machine Installation

Please refer to Figure 7 to fix the tail of the main machine and the connecting bracket with the installation screws, and then manually adjust the telescopic arm to the appropriate length, finally fix the telescopic arm connector and the front mounting bracket with the installation screws. Pull the door after installation to ensure the travel is flexible without jamming.

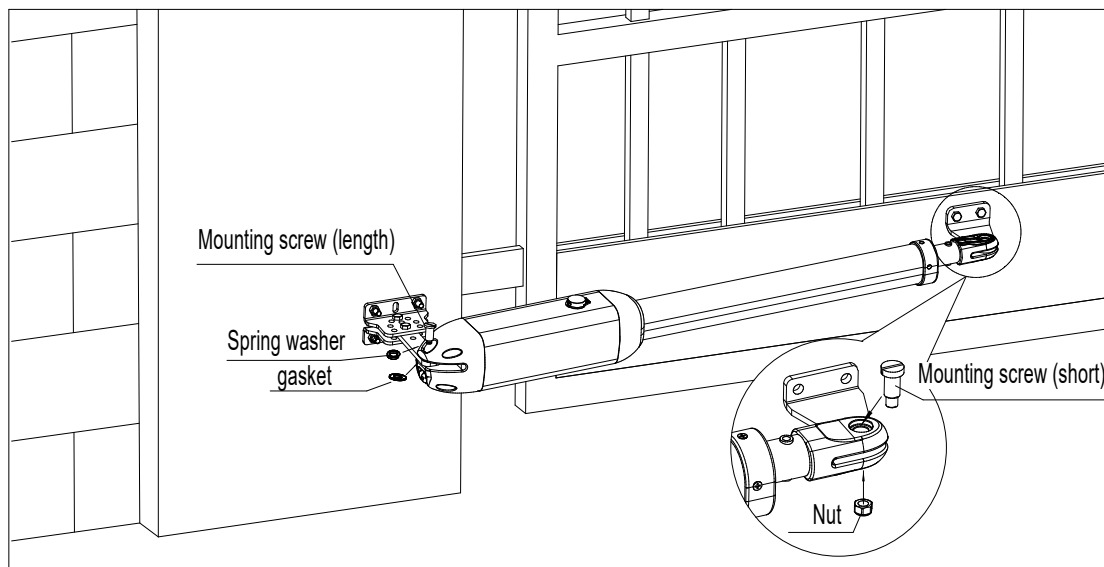

Figure 7

Installation direction: door opens inward

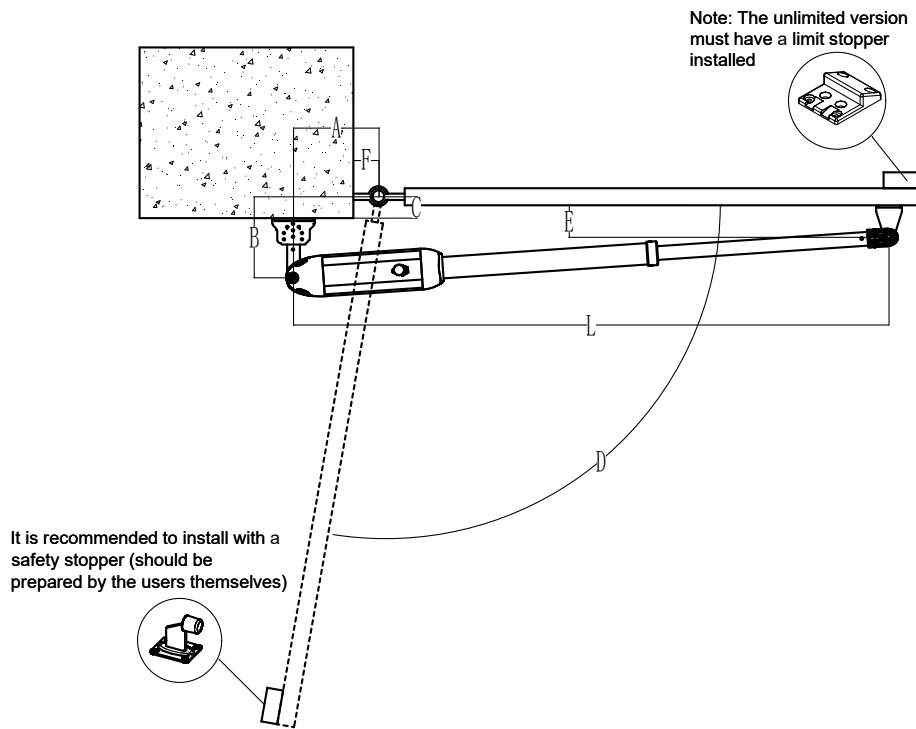

Figure 8

	A(mm)	B(mm)	C(mm)	D max	L(mm)
SIZE	240	115	15	100°	1400
	220	125	25	100°	1440
	200	135	35	100°	1420
	180	145	45	90°	1420

Table 1 Recommended Installation Position

Installation direction: door opens outward

It is recommended to install with a safety stopper (should be prepared by the users themselves)

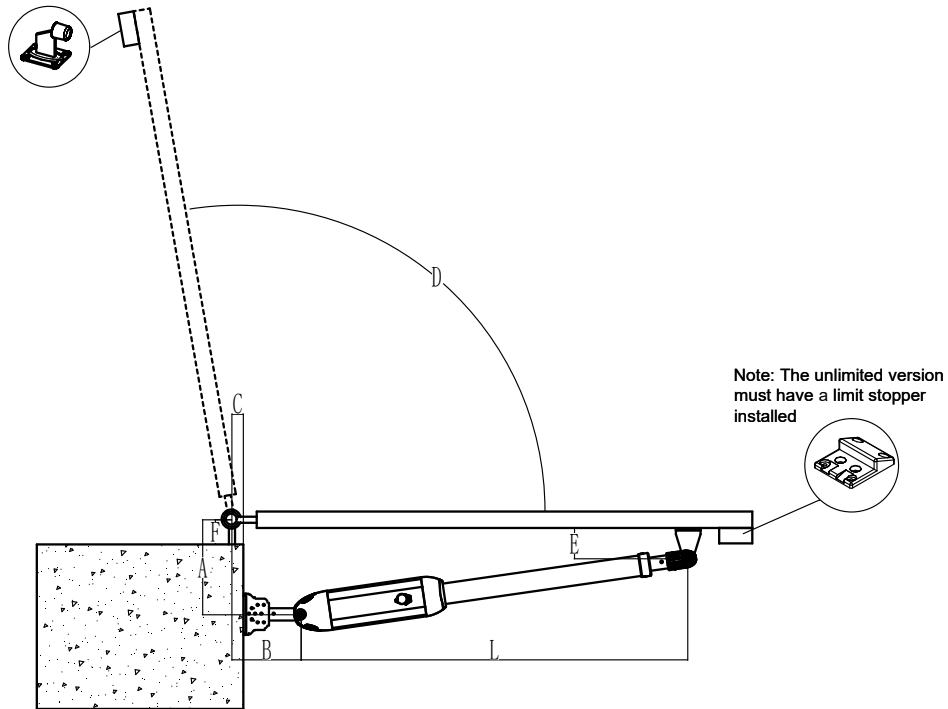

Figure 9

	A(mm)	B(mm)	C(mm)	D max	L(mm)
SIZE	170	170	40	90°	1000
	180	170	30	100°	1000
	190	170	30	100°	1000
	200	180	40	100°	1000

Table 2 Recommended Installation Position

Note: Value B must be close or equal to the value A to reach the best mechanical advantage.

4.3.4 Size of Control Box

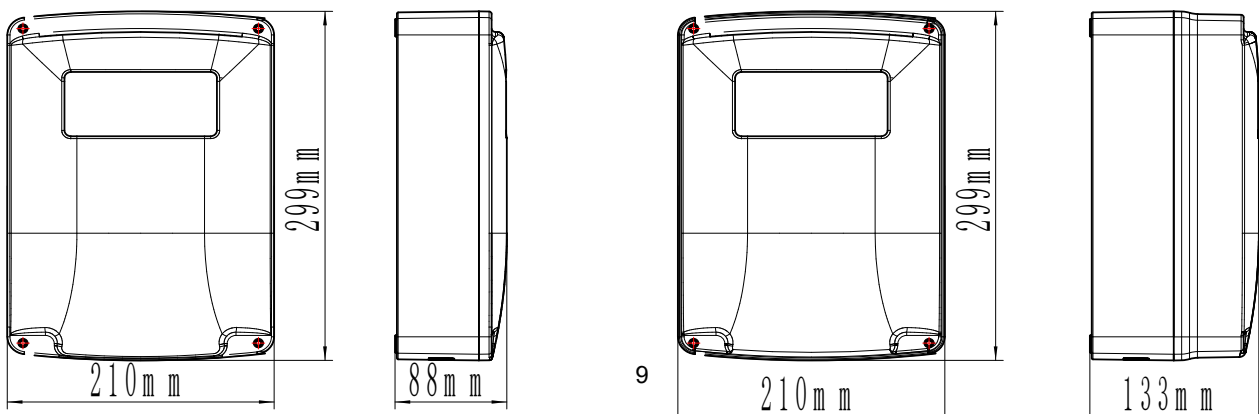

Control box without built-in battery

Control box with built-in battery

Figure 10



Warning

- **To ensure safety, please install the limit stopper at the close limit position when the door opens inward (as shown in figure 8).**
- Before installing the main machine, please make sure the main machine and components are in good mechanical performance and the door can be manually operated flexibly.
- One control unit can optionally drive one main machine or two main machines.
- Earth leakage circuit breaker must be installed on where the gate movement can be seen, and the minimum mounting height for the control box should be over 1.5m to avoid being touched by kids.
- After installation, please check whether the mechanical property is good or not, whether gate movement is flexible or not after unlocking, and whether the infrared sensor (optional) is installed correctly and effectively.

5. Wiring and Debugging

5.1 Wiring Instructions

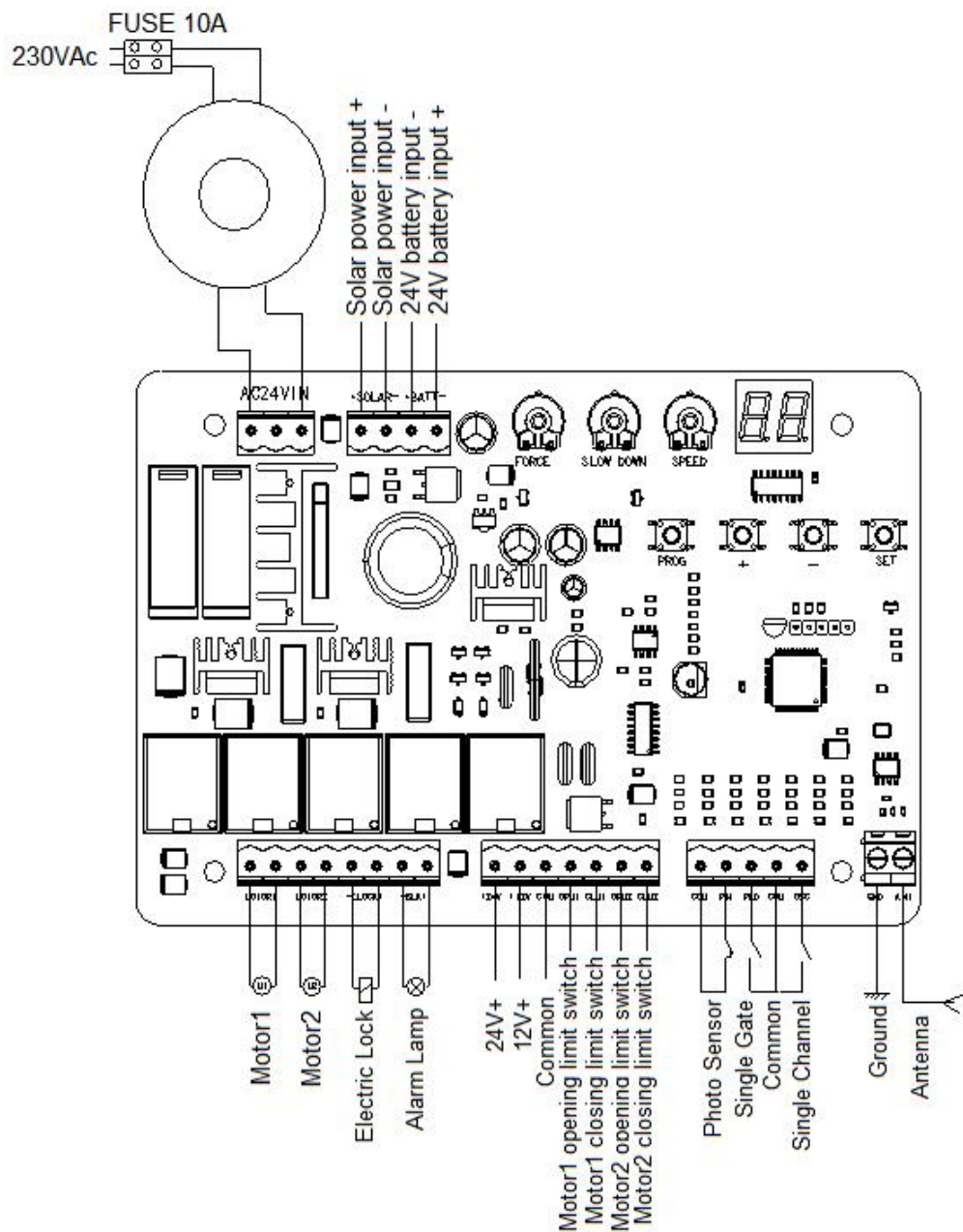

Figure 11

5.2 Control Board Drawing and Instructions

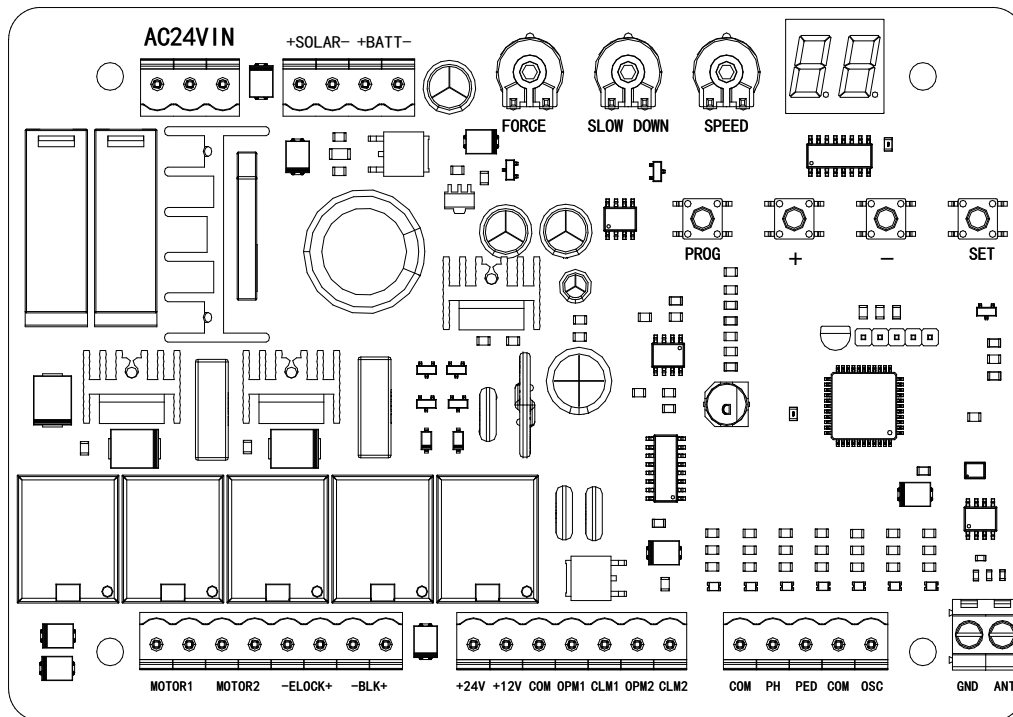
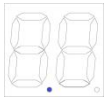

Figure 12

Terminal	Description
1.AC24VIN	24VAC power supply input
2.+SOLAR-	Solar Power Input
3.+BATT-	24V battery Input
4.FORCE	Resistance Force
5.SLOW DOWN	Slow Stop Distance
6.SPEED	Moving Speed
7.MOTOR1	Motor1 Output
8.MOTOR2	Motor2 Output
9.-ELOCK+	Electric Lock Output
10.-BLK+	Alarm Lamp Output (Note: pay attention to the negative and positive.)
11.+24V	24V Output Positive
12.+12V	12V Output Positive (No output under dormant state)
13.OPM1	Motor1 Open Input Active
14.CLM1	Motor1 Close Input Active
15.OPM2	Motor2 Open Input Active
16.CLM3	Motor2 Close Input Active
17.PH	Photo sensor Input Active
18.PED	Single Gate/Pedestrian Mode Input Active
19.OSC	Single Channel Input Active
20.ANT	Antenna
21.COM	Common

5.3 Digital Screen Setting

When the control board is working, the users can check working state of gate opener by digital screen on the control board.



: no input;

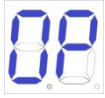

: under opening state;

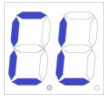

: under closing state;

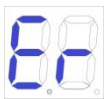

: error;

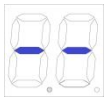

: manual mode;

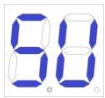

: travel setting;

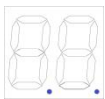

: party mode.

5.4 Travel Setting (VERY IMPORTANT)

In the first installation of gate openers, the installer need to set opening and closing limit switch positions for running the travel.

Fully open both sides of the gate and lock the clutch, and then long press the "-" button on the control board until the digital screen shows "SU". At that time, the gate will firstly run towards the closing direction and stop, and then the gate will automatically open. When the two swing gates are fully open, the gates will automatically close for the second time, and the travel setting will be completed when the gates are closed. If the distance of starting slow speed of gate is not appropriate, adjust the "SLOW DOWN " button to revise the distance.

Note:

- If the suddenly stops during travel setting, please increase the resistance force.
- If the gate has not stopped blocking when meets the blocker during travel setting, please appropriately reduce the resistance force.
- Installer must redo travel setting after modifying the "SPEED" trimmer.

5.5 Trimmers Setting

Obstacle Sensibility Trimmer

To adjust the sensitivity of obstacle -- clockwise to increase, counterclockwise to reduce the sensitivity of obstacle. If there are environmental effects, such as heavy winds, adjust the trimmer according to environment.

Slow Speed Distance Trimmer

To adjust slow speed distance -- clockwise to increase, counterclockwise to decrease slow speed distance. Please do not set very short slow speed distance, to avoid the gate collision.

Gate Moving Speed Trimmer

To adjust gate moving speed -- clockwise to accelerate, counterclockwise to slow down. The trimmer can be adjusted to change the opening and closing travel time. This adjustment must be finished before travel setting.

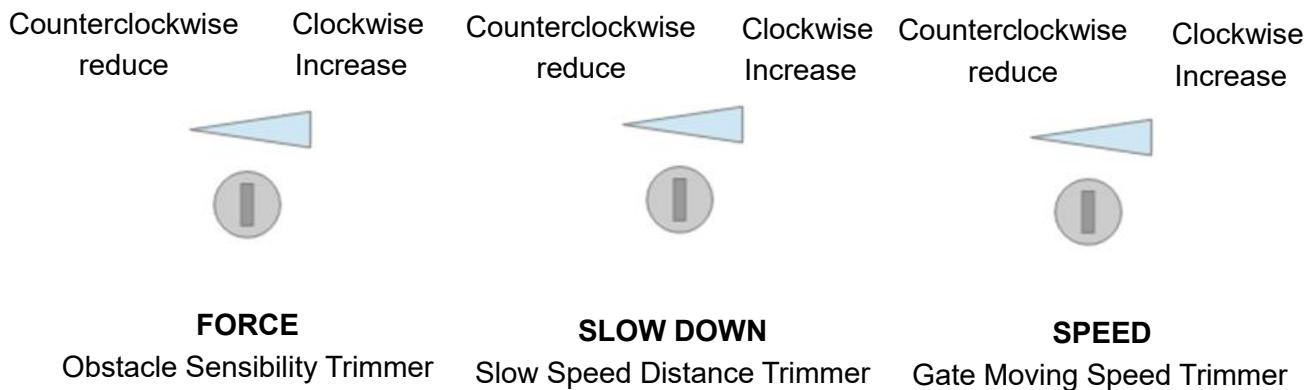

Figure 13

5.6 Learning Remote Control & Delete Remote Control

5.6.1 Learning Remote Control

Long press "+", the alarm light will keep flashing, and digital screen displays remote control mode -- "PO" -- two swing gates single channel mode; "Pd" -- single gate four channel mode; and the current number of paired remote controls. Press the button of the remote control to be learned, the digital screen will show the number of current learned remote control, then the remote control learning is completed. (The default of new paired remote control is two swing gates single channel mode).

5.6.2 Delete Remote Control

Enter into AE in the digital screen and then to choose "rE" to delete the remote controls.

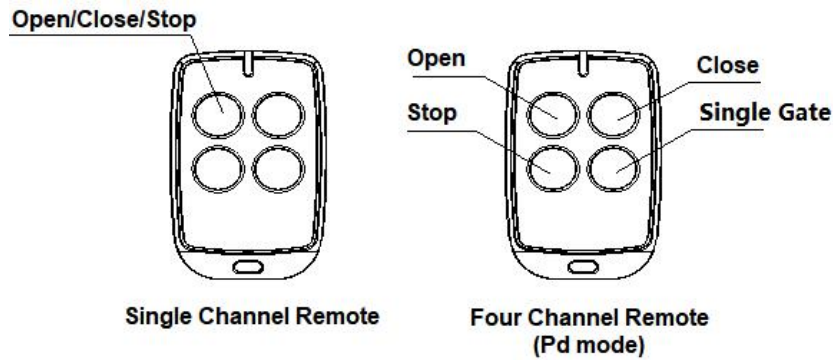

Figure 14

5.6.3 Special Remote Control Key-button

Long press the combination keys for 5S.

- A(open)+D(single gate) combination key -- enter into travel setting;
- B(close)+D(single gate) combination key -- enter/exit party mode; (Party mode: the swing gates can only be opened but cannot be closed. In party mode, the alarm light will flash for 2S when the control board receives signal.)
- C(stop)+D(single gate) combination key -- enter into remote control learning.

5.7 Control Board Settings

5.8 Base Menu

Press "PROG" to enter into base menu;

Digital Screen shows "NE", select other functions of this menu by "+" and "-" buttons.

Press "SET" to confirm or to enter into sub-menu.





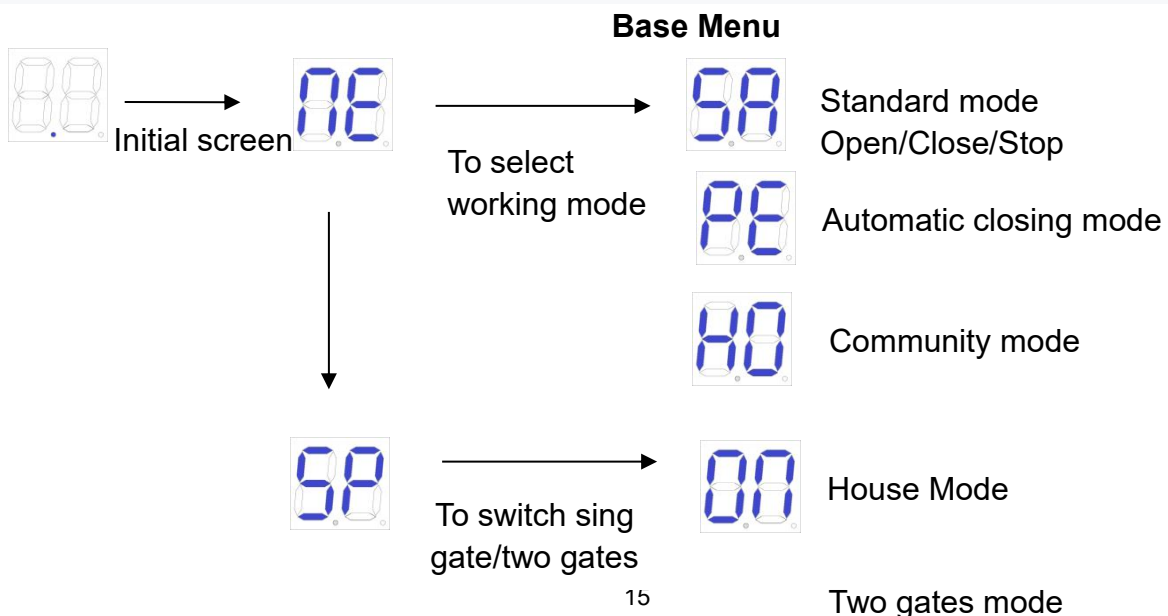

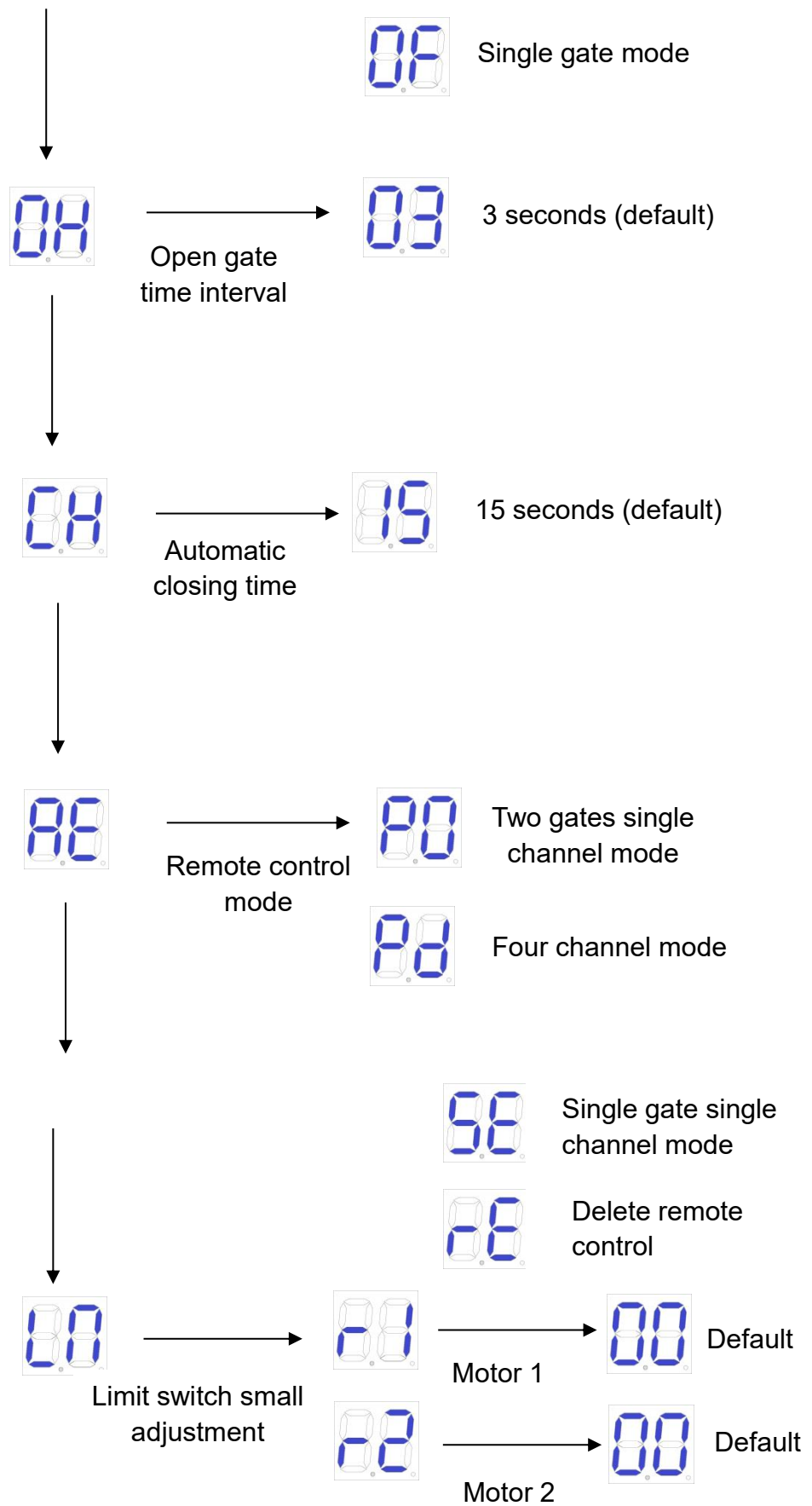



To exit menu, press "PROG".



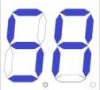



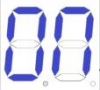

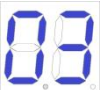

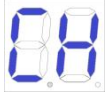
If no command for one minute, the menu will automatically exit.



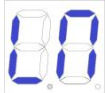

5.8.1 Base Menu Instruction

Menu Press "PROG" to enter into base menu.	Option Press "+"(up) or "-"(down) to select; Press "SET" to confirm.	Default/Attention
 <p>Working Mode</p>	 Standard mode; O/C/S (Open/Close/Stop).  O/S/C standard mode with automatic closing function. When the gate opens, it will automatically close after automatic closing time. If a "close the gate" command is sent during the automatic closing time waiting time, the automatic closing function will be canceled.  Community mode(with automatic closing function). When the gate opens, any gate command will not be responded until it closes automatically. If user sends gate command during the closing process, then the gate will reopen. If a gate command is sent during the automatic closing waiting time, this waiting time will be recalculated. If the gate is not closed completely for more than three consecutive times, the automatic closing function will be canceled and the gate will be closed by re-sending the door closing command. Note that in community mode, the door still has the automatic closing function in case of meeting obstacles.	 Standard mode; O/C/S (Open/Close/Stop).
 <p>Single Gate/Two Gates Switch</p>	 Two gate mode(default).  Single gate mode.	 Two gate mode.
 <p>Open Gate Time Interval</p>	 00-10: Open gate time interval is 0-15 seconds(default 3 seconds). If the interval shorter than 2 seconds, then the electric lock cannot be used.	 3 seconds.

 Automatic Closing Time	 Automatic closing time can be set as 15(default), 30, 60, 90 seconds.	 15 seconds.
 Remote Control Mode	 Two gates single channel mode.  Four channel mode.  Single gate single channel mode.  Delete all paired remote controls	
 Limit Switch Small Adjustment	 Increasing the value of "r1" can extend the closing limit position of gate1.  Increasing the value of "r2" can extend the closing limit position of gate2. Note: this value applies only for electronic limit. The value cannot be increased indefinitely and it is only used for small adjustment after manually set the limit switch positions.	

5.9 Advanced Menu

Long press "PROG" 2 seconds to enter into advanced menu.
Digital Screen shows "PH", press "+"(up) or "-"(down) to select;
Short press "SET" to confirm or to enter into sub-menu.
Short press "PROG" to exit.
If no command for one minute, the menu will automatically exit.

Advanced Menu

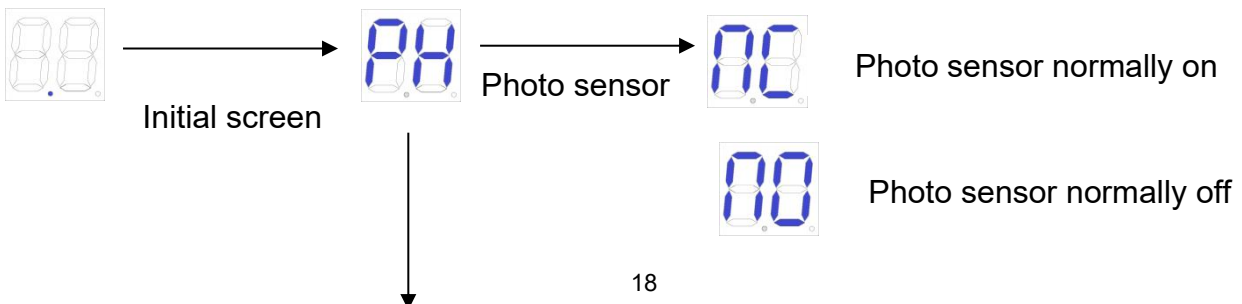

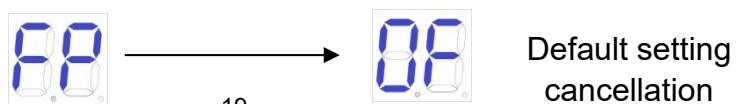
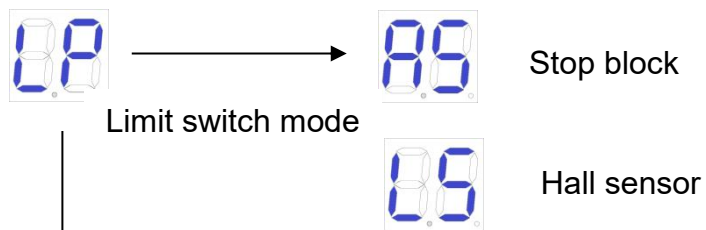
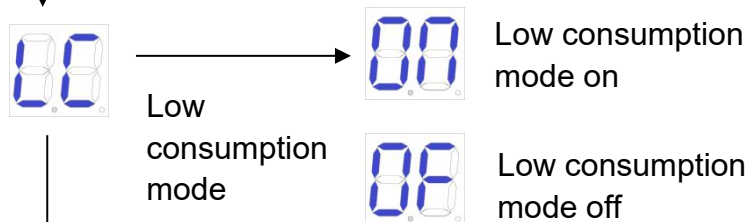
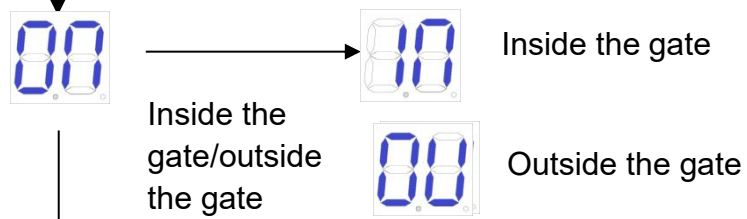
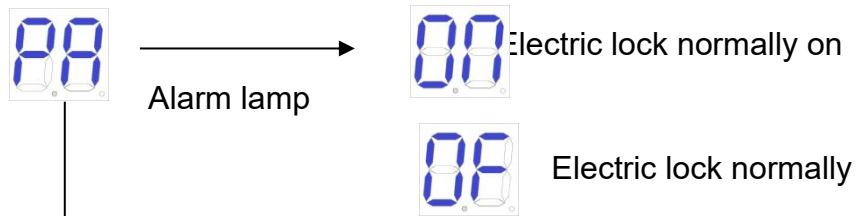
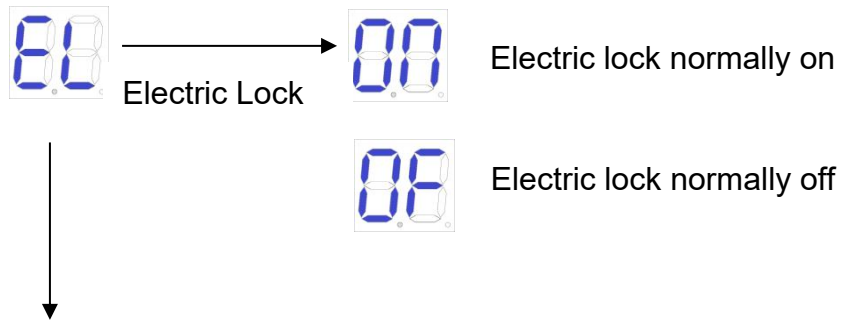









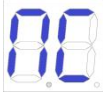
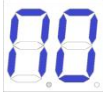
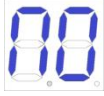

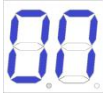

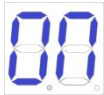

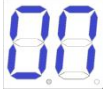

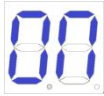
Factory default
setting

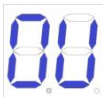
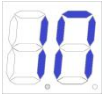
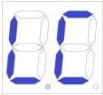
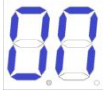

Default setting
completion

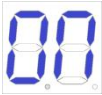
5.9.1 Advanced Menu Instruction

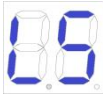
<p>Menu</p> <p>Long press "PROG" 2 seconds to enter into base menu.</p>	<p>Option</p> <p>Press "+"(up) or "-"(down) to select; Press "SET" to confirm.</p>	<p>Default/Attention</p>
 <p>Photo Sensor</p>	 N/C; photo sensor normally is on.  N/O; photo sensor normally off. (Default)	 N/O; photo sensor normally on.
 <p>Electric Lock</p>	 Electric lock normally is on. (Default)  Electric lock normally is off.	 Electric lock normally on.
 <p>Alarm Lamp</p>	 Alarm lamp normally is on. 24V power supply. (Default)  Alarm lamp normally flashes. 24V power supply.	 Alarm lamp normally is on. 24V power supply.

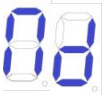
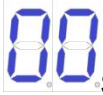
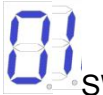
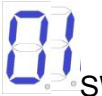
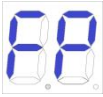
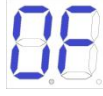
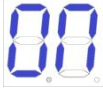
 <p>Inside the Gate/Outside the Gate</p>	 Inside the gate. (Default)  Outside the gate.	 Inside the gate.
 <p>Low Consumption Mode</p>	 Low consumption mode on. The control board will automatically enter low-consumption mode after one minute when there is no operation at the initial screen. (Default)  Low consumption mode off.	 Low consumption mode on.
 <p>Limit Switch Mode</p>	 Stop block. (Default)  Hall sensor.	 Stop block.
 <p>Swing Gate Open Model</p>	 SW400DC.  SW300DC. (Default)	 SW300DC.
 <p>Factory Default Setting</p>	 Cancel factory default setting.  Factory default setting completes.	

6. Others

6.1 Maintenance

Check whether the gate operates normally every month.

For the sake of safety, each gate is suggested to be equipped with infrared protector, and regular inspection is required as well.

Before installation and operation of the gate opener, please read all instructions carefully.

We reserve the right to change the instruction without prior notice.

10.2 Troubleshooting

Problems	Possible Reasons	Solutions
The gate cannot open or close normally, and Display does not light.	<ol style="list-style-type: none">1.The power is off.2.Fuse is burned.3.Control board power wiring with problem.	<ol style="list-style-type: none">1.Switch on the power supply.2.Check the fuse, change the fuse if burnt.3.Re wiring according to instructions.
The gate can open but cannot close.	<ol style="list-style-type: none">1.Photocell wiring with problem.2.Photocell mounting with problem.3.Photocell is blocked by objects.4.Sensitivity of obstacle is too high.	<ol style="list-style-type: none">1.If not connect photocell, please make sure that the 5 and 6, 5 and 7 short circuit; if connect infrared sensor, please make sure the wiring is correct and the photocell is N.C.2.Make sure that the photocell mounting position can be mutually aligned.

		3.Remove the obstacle. 4.Reduce the sensitivity of obstacle.
Remote control doesn't work.	1.Battery level of the remote control is low. 2.Remote control learning is not completed.	1.Change the remote control battery. 2.Re-conduct remote control learning.
Press OPEN, CLOSE button, the gate is not moving, motor has noise.	Gate moving is not smoothly.	According to the actual situation to adjust the motor or the gate.
Leakage switch tripped.	Power supply line short circuit or motor line short circuit.	Check wiring.
Remote control working distance is too short.	Signal is blocked.	Connect external receiver antenna, 1.5 meters above ground.
The gate moves to the middle position to stop or reverse.	1.Motor output force is not enough. 2.Sensitivity of obstacle is too high. 3.Gate meets obstacle.	1.Check whether the transformer power is normal, if not, change the transformer. 2.Adjust the TR2. 3.Remove the obstacle.

Warranty

Warranty Ordinance

1. To repair against this warranty card and invoice during the warranty period.
2. Warranty period: 1 year after the date of invoice.
3. Without unauthorized dismantling, any product broken or damage due to quality problem, we'll offer the repair service for free or replace for free.
4. The malfunction and damages caused by incorrect use or man fault is not covered by this warranty.

Maintenance Record

Check Date	Check Content	Maintained by